

# TRIKKE® uPT

ultralight Personal Transporter



**Dynamic  
Cambering** 3-point  
(leaning) stability  
**Frame**

**Standing,  
active riding  
experience**

*Stable for cruising  
and high-speed  
cornering*

**Lightweight,  
lithium-electric  
power**









**FAIRING  
AVAILABLE**



**TRIKKE**

**TRIKKE**

## Technical Specifications

	Pon-e36V	Pon-e48V			
<b>FRAME</b>	<b>Weight</b>	18,1 kg	20,4 kg		
	<b>Frame</b>	6061 T6 aluminum with patented high performance			
	<b>Brakes</b>	Disk Brake 126mm (Rear wheels, Independent)			
	<b>Wheels</b>	9,5inch Alloy Rim with abac5 sealed bearings			
	<b>Tires Front</b>	10x2,5 inch Motorcycle Grade Hi-pressure Inflatable Tire	10x2,5 inch Non-marking Motorcycle Grade Hi-pressure Inflatable Tire		
	<b>Tires Rear</b>	9,5x2,5 inch Heavy Duty Hi-pressure Inflatable Tire	9,5x2,5 inch Heavy Duty Hi-pressure Inflatable Tire		
<b>ELECTRIC</b>	<b>Battery</b>	36v 9000mAh 324Wh Li-Ion Panasonic cells	48v 11250mAh 540Wh Li-Ion Panasonic cells		
	<b>Charger</b>	42.5V 1.5A	54.5V 3A		
	<b>Charge time</b>	5 hrs	3,5 hrs		
	<b>Motor</b>	36v 250w brushless Geared Hub Motor Free-wheel clutch	48v 350w brushless Geared Hub Motor Free-wheel clutch		
	<b>Controller</b>	PWM 36V – 18A	PWM 48V – 24A		
	<b>Throttle</b>	1/3 Twist Grip with battery state indicator			
<b>PERFORMANCE</b>		<b>Econo</b>	<b>Express</b>	<b>Econo</b>	<b>Express</b>
	<b>*Speed</b>	19 km/h	27 km/h	19 km/h	27 km/h
	<b>**Range</b>	32 km/h	19 km/h	45 km/h	26 km/h
	<small>* Speed and acceleration will vary with rider's weight.</small>				
	<small>** Range will vary with topography, rider's weight, wind and riding style.</small>				
<b>COLORS</b>	<b>Available Frame colors</b>	 Pearl yellow  Green metallic	 Matte black  Pearl white		
		 Royal blue  Cherry red	 Matte silver		

### FEATURES

- Foldable
- Adjustable Handlebar Height
- Hot-swappable Li-Ion Battery with Key-ignition/locking feature
- Dual Speed (Econo & Express)
- Parking brakes
- Ready for Lights Accessory
- Ready for Fairing kit

### DIMENSIONS

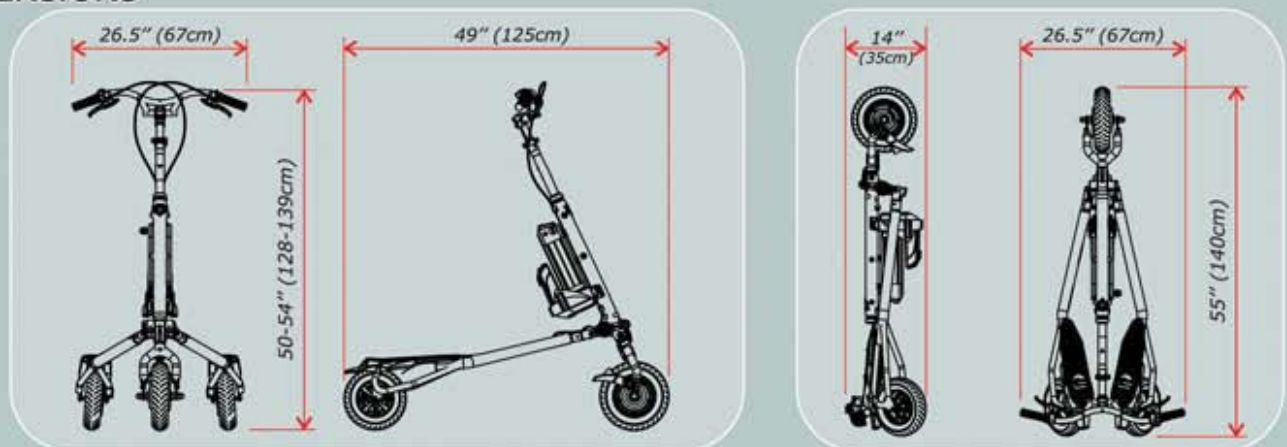

Quickly folds for travel and storage